

# OGRE<sup>®</sup>

ogre.sjgames.com

# KICKSTARTER

## Stretch Goal #1

Version 1.0 (April 2012)

Ogre and the all-seeing pyramid are registered trademarks of Steve Jackson Games.

Kickstarter is a trademark of Kickstarter Inc.

These designs are copyright © 2012 by Steve Jackson Games Incorporated. All rights reserved.  
Ogre line drawings and 3-D designs by Richard Kerr, based on Winchell Chung's original (1977) image.

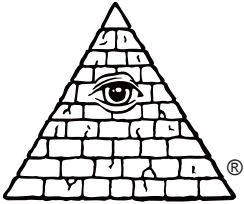

**STEVE  
JACKSON  
GAMES**

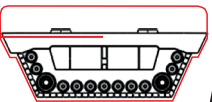
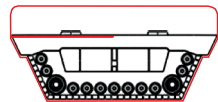
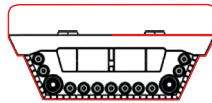
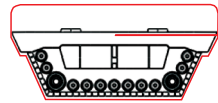
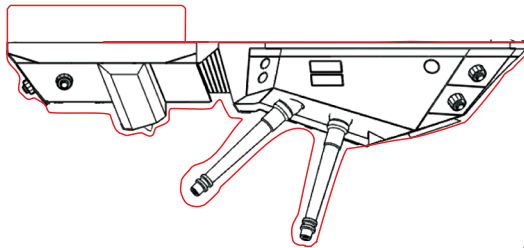
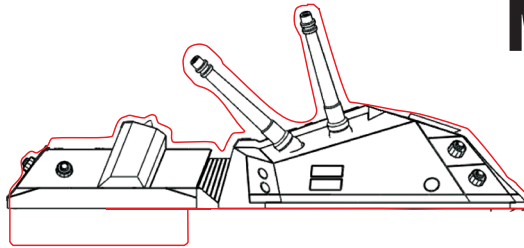
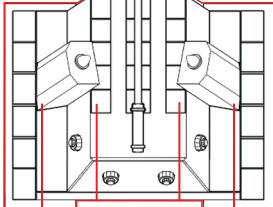
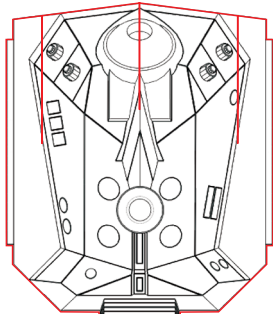

### MK III

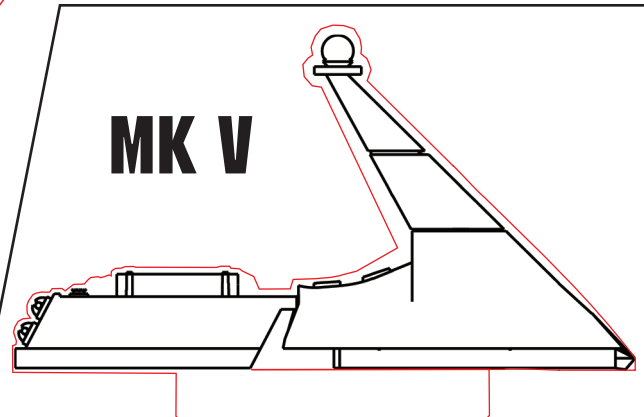
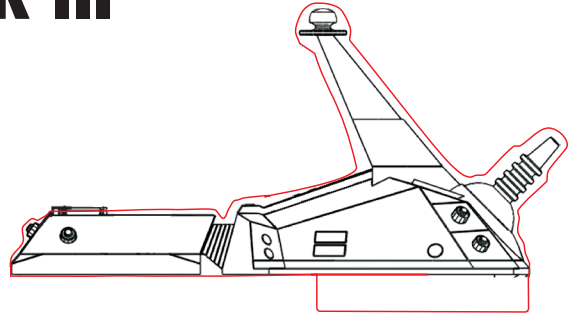

### MK V

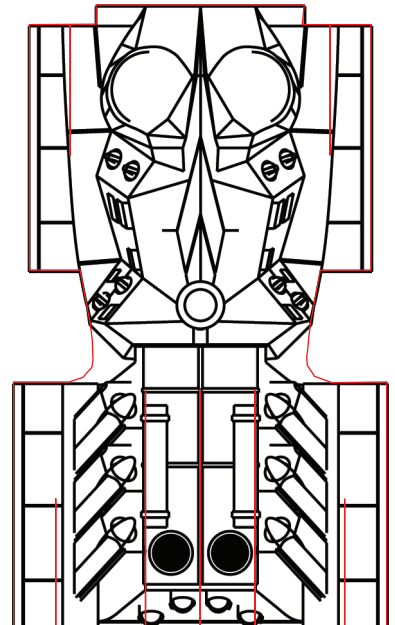
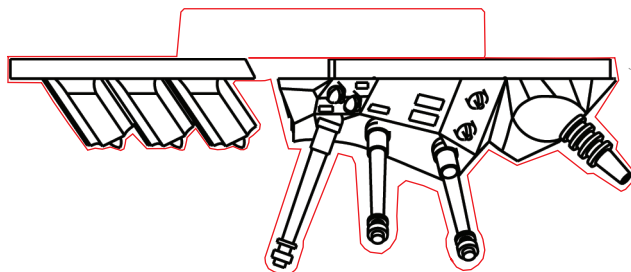
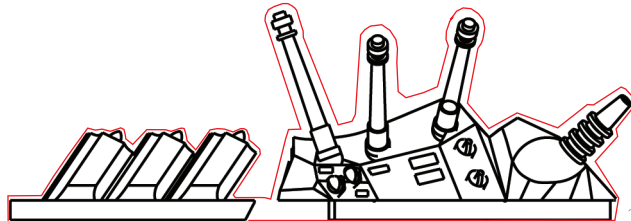
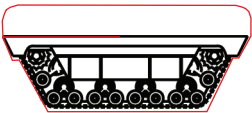
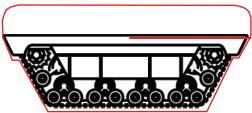
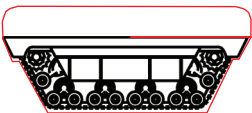
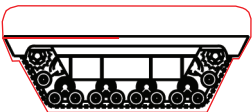

This is the first stretch goal for the *Ogre* 6th Edition Kickstarter project. Thanks to our supporters, everybody gets these blank outlines of the Mk III and Mk V – one each with the Ogre drawn in, and one completely blank. You are welcome to print them out and color them (or vice versa) and build your own Ogres. Send us pictures at [ogrepix@sjgames.com](mailto:ogrepix@sjgames.com)!

The slits are shown as red lines. Cut them slightly thinner than the width of the stock you mount them on. We cut ours out with a laser. Lasers are cool. If you are using a hobby knife, take your time and be careful.

For assembly instructions, see the video at <http://youtu.be/xFVS8D6gNGs>.

You may post your colored versions online, as long as the text and images on this sheet are left intact. You may add your name, URL, twitter handle, etc. Please do not **SELL** the sheets or finished Ogres – we made these to be giveaways.

Enjoy!

– Steve Jackson

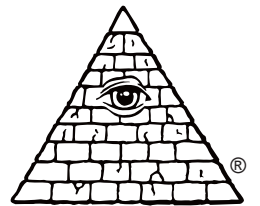

**STEVE  
JACKSON  
GAMES**

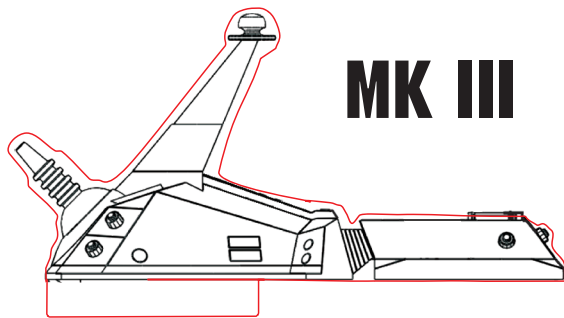

**MK III**

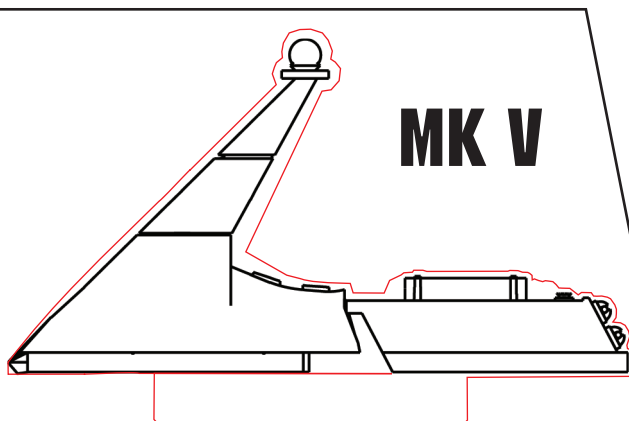
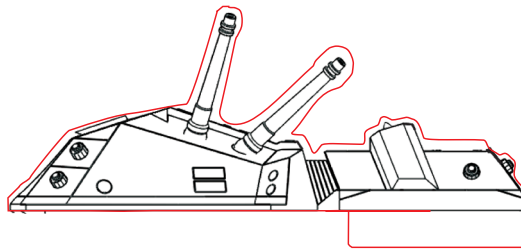

**MK V**

